

100V N-Ch Power MOSFET

Feature

- ◇ Optimized for high speed switching, Logic level
- ◇ Enhanced Body diode dv/dt capability
- ◇ Enhanced Avalanche Ruggedness
- ◇ 100% UIS Tested, 100% Rg Tested
- ◇ Lead Free, Halogen Free

Application

- ◇ DC-DC Conversion
- ◇ Hard Switching and High Speed Circuit
- ◇ Power Tools
- ◇ UPS
- ◇ SSR

V_{DS}		100	V
$R_{DS(on),typ}$	$V_{GS}=10V$	6.4	mΩ
$R_{DS(on),typ}$	$V_{GS}=4.5V$	7.8	mΩ
I_D (Silicon Limited)		105	A
I_D (Package Limited)		70	A

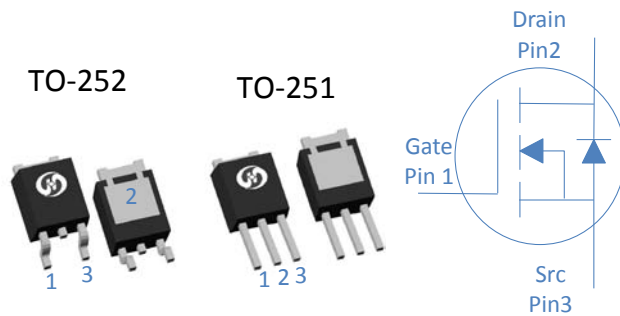

Part Number	Package	Marking
HGD077N10SL	TO-252	GD077N10SL
HGI077N10SL	TO-251	GI077N10SL

Absolute Maximum Ratings at $T_j=25^{\circ}C$ (unless otherwise specified)

Parameter	Symbol	Conditions	Value	Unit
Continuous Drain Current (Silicon Limited)	I_D	$T_C=25^{\circ}C$	105	A
		$T_C=100^{\circ}C$	74	
		Continuous Drain Current (Package Limited)	$T_C=25^{\circ}C$	
Drain to Source Voltage	V_{DS}	-	100	V
Gate to Source Voltage	V_{GS}	-	± 20	V
Pulsed Drain Current	I_{DM}	-	350	A
Avalanche Energy, Single Pulse	E_{AS}	$L=0.3mH, T_C=25^{\circ}C$	240	mJ
Power Dissipation	P_D	$T_C=25^{\circ}C$	150	W
Operating and Storage Temperature	T_J, T_{stg}	-	-55 to 175	$^{\circ}C$

Absolute Maximum Ratings

Parameter	Symbol	Max	Unit
Thermal Resistance Junction-Case	$R_{\theta JC}$	1	$^{\circ}C/W$
Thermal Resistance Junction-Ambient	$R_{\theta JA}$	46	$^{\circ}C/W$

Electrical Characteristics at T_j=25°C (unless otherwise specified)
Static Characteristics

Parameter	Symbol	Conditions	Value			Unit
			min	typ	max	
Drain to Source Breakdown Voltage	V _{(BR)DSS}	V _{GS} =0V, I _D =250μA	100	-	-	V
Gate Threshold Voltage	V _{GS(th)}	V _{GS} =V _{DS} , I _D =250μA	1.4	1.9	2.4	
Zero Gate Voltage Drain Current	I _{DSS}	V _{GS} =0V, V _{DS} =100V, T _j =25°C	-	-	1	μA
		V _{GS} =0V, V _{DS} =100V, T _j =100°C	-	-	100	
Gate to Source Leakage Current	I _{GSS}	V _{GS} =±20V, V _{DS} =0V	-	-	±100	nA
Drain to Source on Resistance	R _{DS(on)}	V _{GS} =10V, I _D =20A	-	6.4	7.7	mΩ
		V _{GS} =4.5V, I _D =20A	-	7.8	10.0	
Transconductance	g _{fs}	V _{DS} =5V, I _D =20A	-	75	-	S
Gate Resistance	R _G	V _{GS} =0V, V _{DS} Open, f=1MHz	-	1.6	-	Ω

Dynamic Characteristics

Input Capacitance	C _{iss}	V _{GS} =0V, V _{DS} =50V, f=1MHz	-	3350	-	pF
Output Capacitance	C _{oss}		-	270	-	
Reverse Transfer Capacitance	C _{rss}		-	15	-	
Total Gate Charge	Q _g (10V)	V _{DD} =50V, I _D =20A, V _{GS} =10V	-	49	-	nC
Total Gate Charge	Q _g (4.5V)		-	21	-	
Gate to Source Charge	Q _{gs}		-	8	-	
Gate to Drain (Miller) Charge	Q _{gd}		-	7	-	
Turn on Delay Time	t _{d(on)}	V _{DD} =50V, I _D =20A, V _{GS} =10V, R _G =10Ω,	-	10	-	ns
Rise time	t _r		-	5	-	
Turn off Delay Time	t _{d(off)}		-	32	-	
Fall Time	t _f		-	6	-	

Reverse Diode Characteristics

Diode Forward Voltage	V _{SD}	V _{GS} =0V, I _F =20A	-	0.9	1.2	V
Reverse Recovery Time	t _{rr}	V _R =50V, I _F =20A, dI _F /dt=500A/μs	-	47	-	ns
Reverse Recovery Charge	Q _{rr}		-	226	-	nC

Fig 1. Typical Output Characteristics

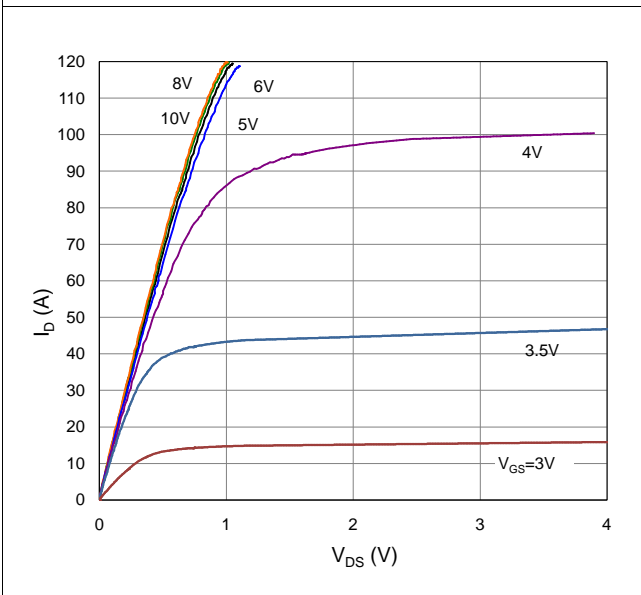

Figure 2. On-Resistance vs. Gate-Source Voltage

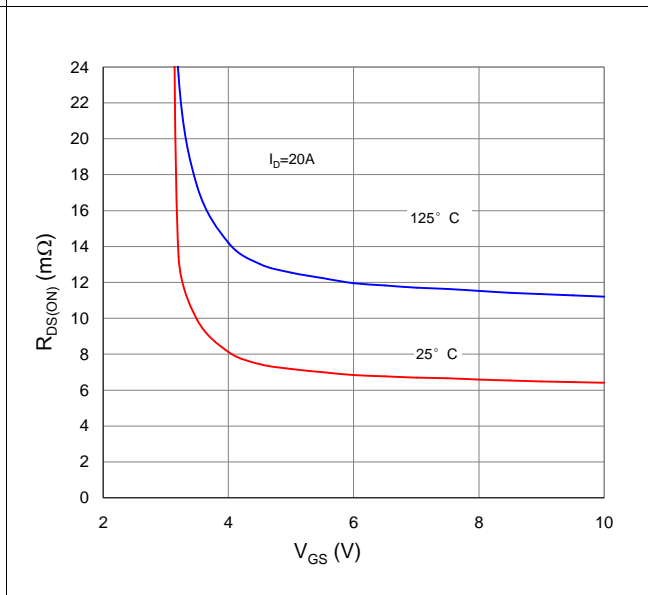

Figure 3. On-Resistance vs. Drain Current and Gate Voltage

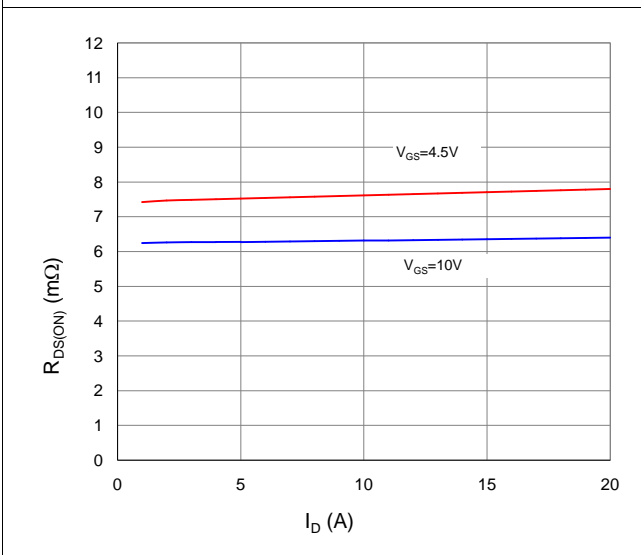

Figure 4. Normalized On-Resistance vs. Junction Temperature

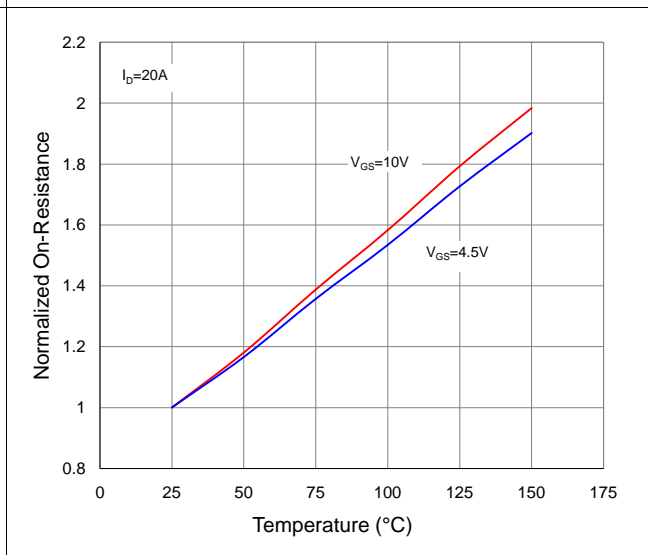

Figure 5. Typical Transfer Characteristics

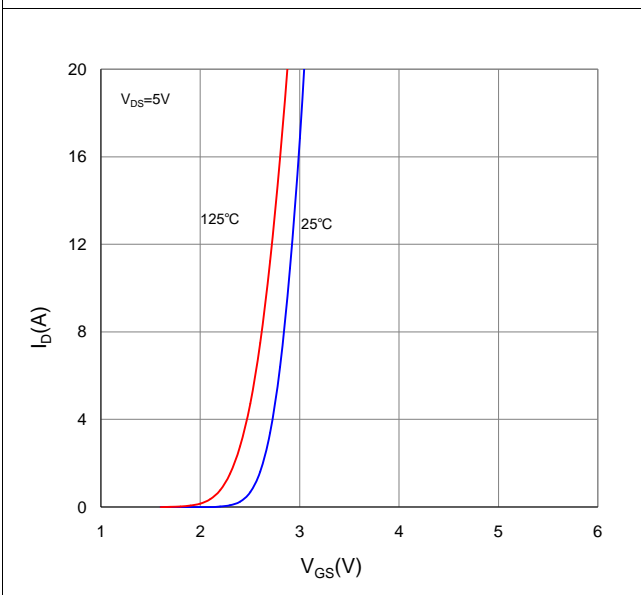

Figure 6. Typical Source-Drain Diode Forward Voltage

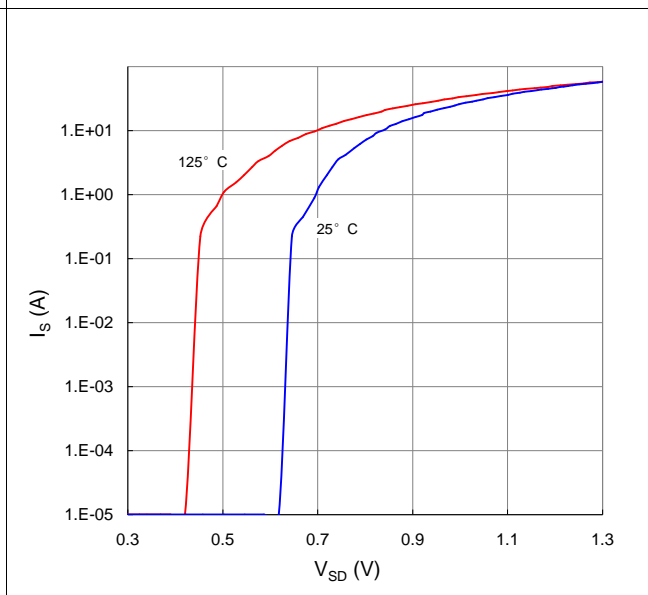

Figure 7. Typical Gate-Charge vs. Gate-to-Source Voltage

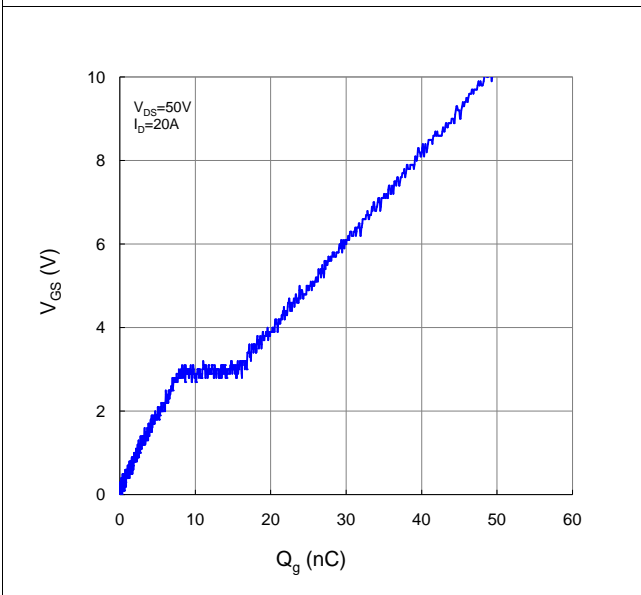

Figure 8. Typical Capacitance vs. Drain-to-Source Voltage

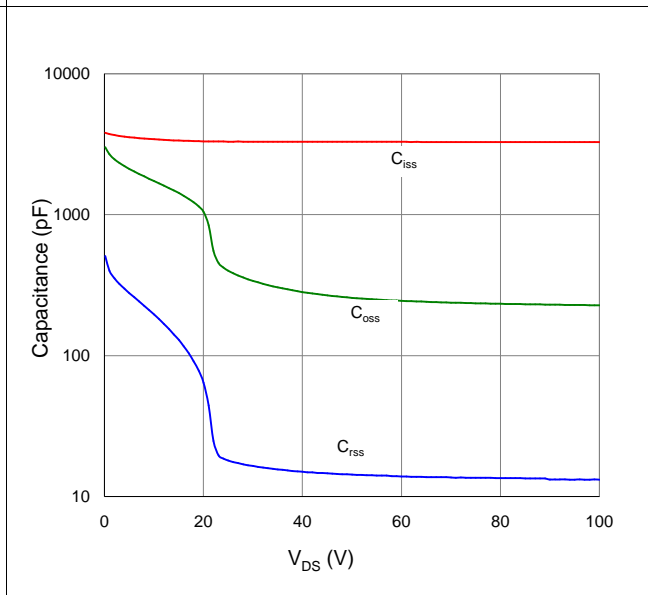

Figure 9. Maximum Safe Operating Area

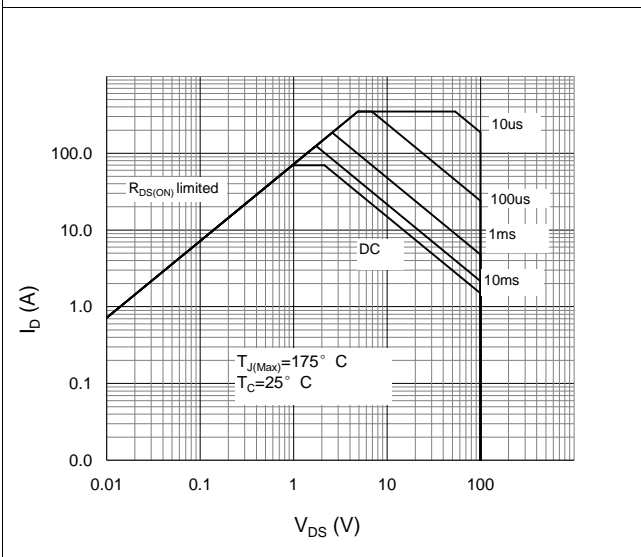

Figure 10. Maximum Drain Current vs. Case Temperature

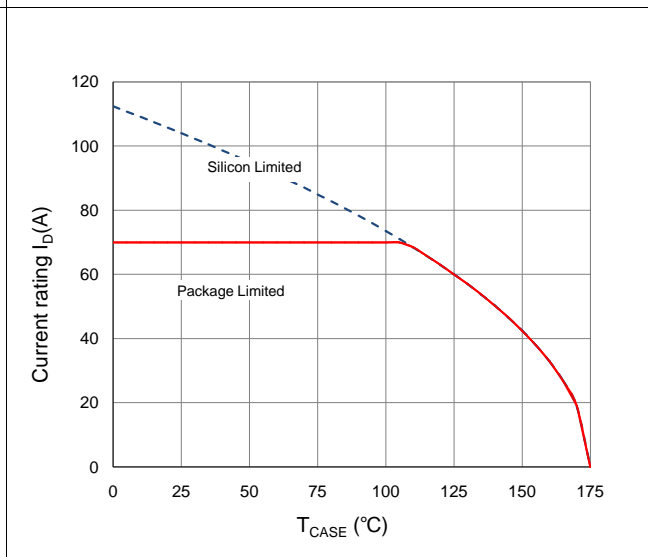
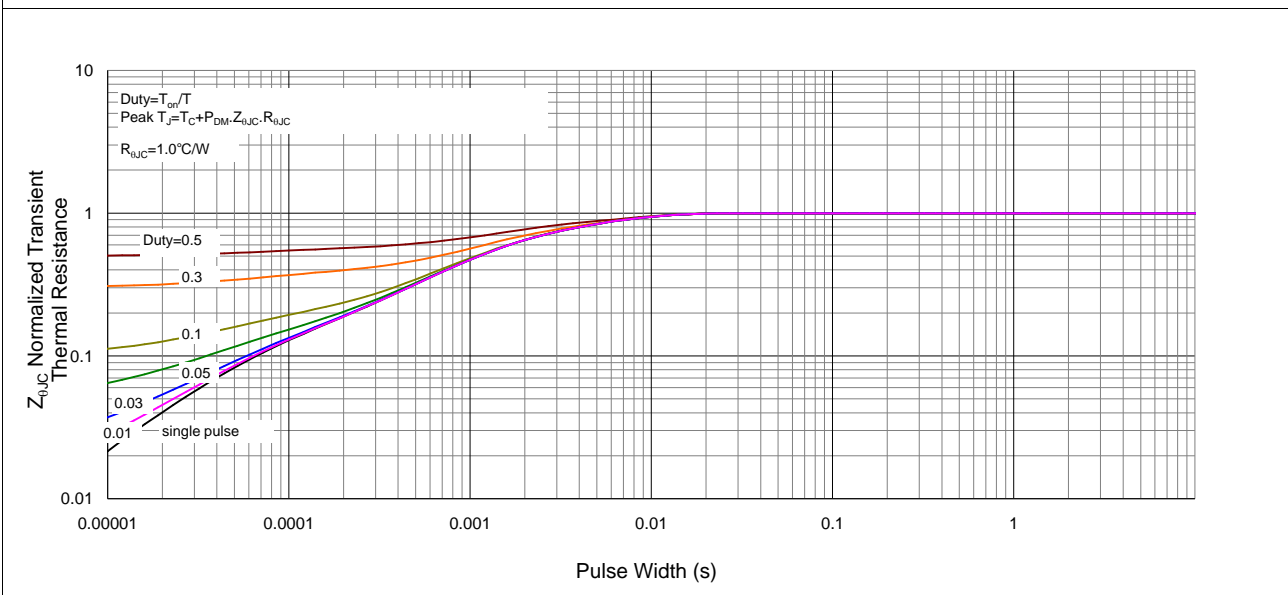
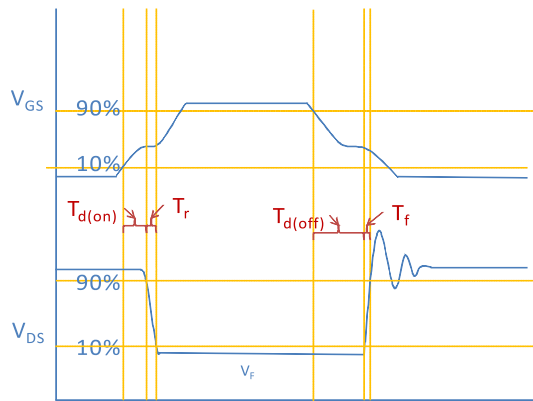
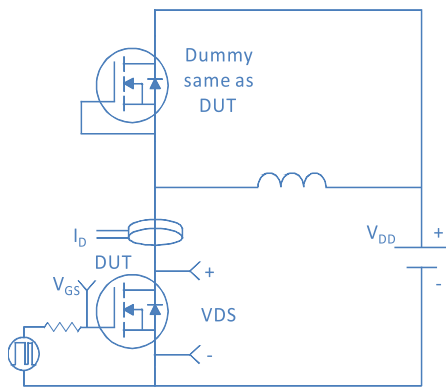

Figure 11. Normalized Maximum Transient Thermal Impedance, Junction-to-Case



Inductive switching Test



Gate Charge Test

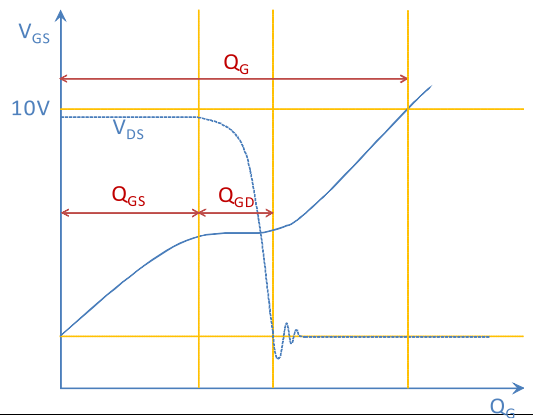
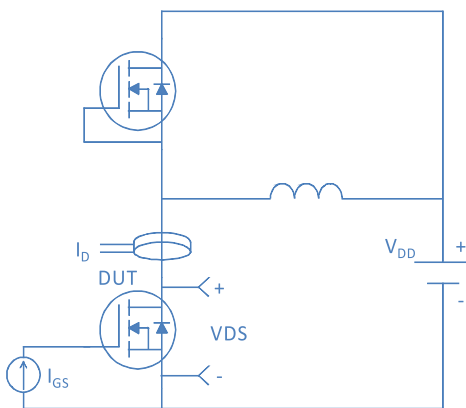

Uclamped Inductive Switching (UIS) Test

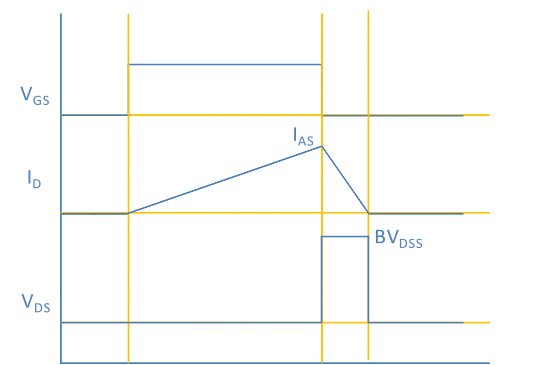

Diode Recovery Test

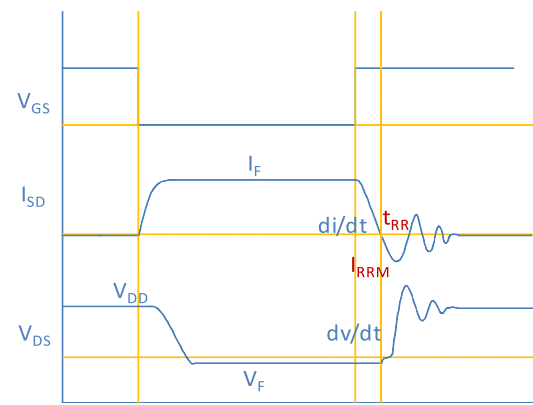

Package Outline

TO-252 2 leads

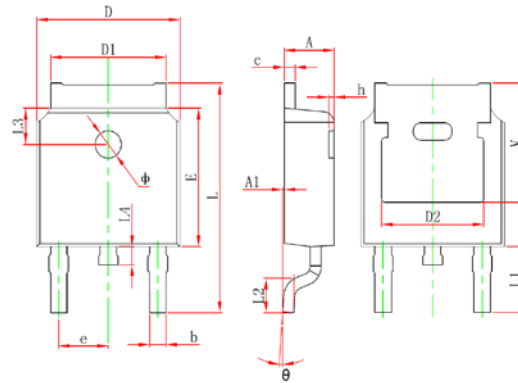

Symbol	Dimensions In Millimeters		Dimensions In Inches	
	Min.	Max.	Min.	Max.
A	2.200	2.400	0.087	0.094
A1	0.000	0.127	0.000	0.005
b	0.660	0.860	0.026	0.034
c	0.460	0.580	0.018	0.023
D	6.500	6.700	0.256	0.264
D1	5.100	5.460	0.201	0.215
D2	4.830 REF.		0.190 REF.	
E	6.000	6.200	0.236	0.244
e	2.186	2.386	0.086	0.094
L	9.800	10.400	0.386	0.409
L1	2.900 REF.		0.114 REF.	
L2	1.400	1.700	0.055	0.067
L3	1.600 REF.		0.063 REF.	
L4	0.600	1.000	0.024	0.039
Φ	1.100	1.300	0.043	0.051
θ	0°	8°	0°	8°
h	0.000	0.300	0.000	0.012
V	5.350 REF.		0.211 REF.	

TO-251, 3 leads

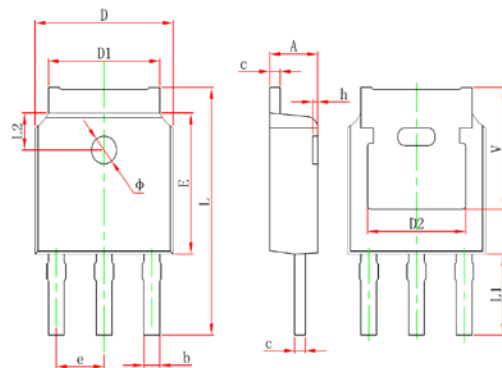

Symbol	Dimensions In Millimeters		Dimensions In Inches	
	Min.	Max.	Min.	Max.
A	2.200	2.400	0.087	0.094
b	0.660	0.860	0.026	0.034
c	0.460	0.580	0.018	0.023
D	6.500	6.700	0.256	0.264
D1	5.100	5.460	0.201	0.215
D2	4.830 REF.		0.190 REF.	
E	6.000	6.200	0.236	0.244
e	2.186	2.386	0.086	0.094
L	10.400	11.000	0.409	0.433
L1	3.500 REF.		0.138 REF.	
L2	1.600 REF.		0.063 REF.	
Φ	1.100	1.300	0.043	0.051
h	0.000	0.300	0.000	0.012
V	5.350 REF.		0.211 REF.	